

### Specifications

#### Nominal Voltage(V)

12V

#### Nominal Capacity

20 hour rate	(1.3A	to	10.50V)	26Ah
10 hour rate	(2.47A	to	10.50V)	24.7Ah
5 hour rate	(4.42A	to	10.20V)	22.1Ah
1 C	(26A	to	9.60V)	14.73Ah
3 C	(78A	to	9.60V)	10.4Ah

#### Weight

Approx. 9.3kg(20.5Lbs.)

#### Internal Resistance (at 1KHz)

Approx. 9.5 mΩ

#### Maximum Discharge Current for

5 seconds: 390A

#### Charging Methods at 25°C(77°F)

Cycle use:	
Charging Voltage	14.4 to 15.0V
Coefficient -5.0mV/°C/cell	
Maximum Charging Current :	7.8A
Standby use:	
Float Charging Voltage	13.5 to 13.8V
Coefficient -3.0mV/°C/cell	

#### Operating Temperature Range

Charge	-15°C(5°F)	to	40°C(104°F)
Discharge	-15°C(5°F)	to	50°C(122°F)
Storage	-15°C(5°F)	to	40°C(104°F)

#### Charge Retention (shelf life) at 20°C(68°F)

1 month	92%
3 month	90%
6 month	80%

#### Case Material

ABS UL94 HB  
Option: Flammability resistance of (UL94 V-0)

#### Design Life

3-5 Years.

#### Terminal

F3



### Dimensions

Length (L)	166±2-1 (6.54±0.08-0.04)
Width (W)	175±2-1 (6.89±0.08-0.04)
Height (H)	125±2-1 (4.92±0.08-0.04)
Overall Height (HT)	125±2-1 (4.92±0.08-0.04)

mm(inch)

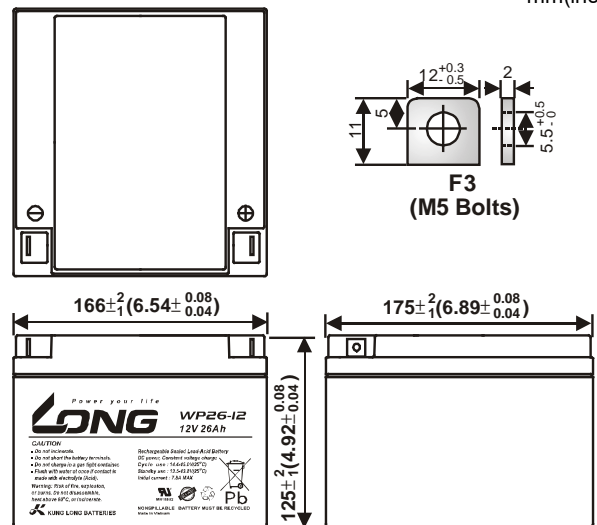

(V) FOR 12V BATTERY Discharge Time VS. Discharge Current (25°C)

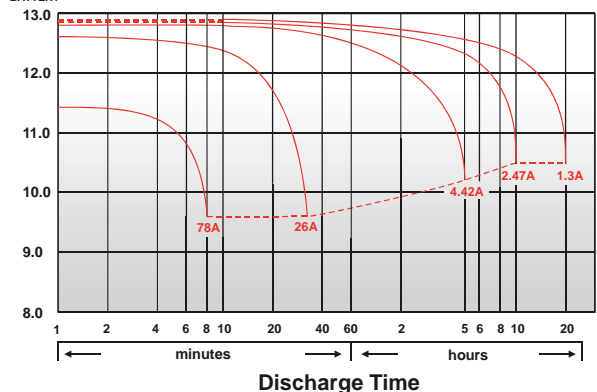

Effect of Temperature on Capacity 25°C(77°F)

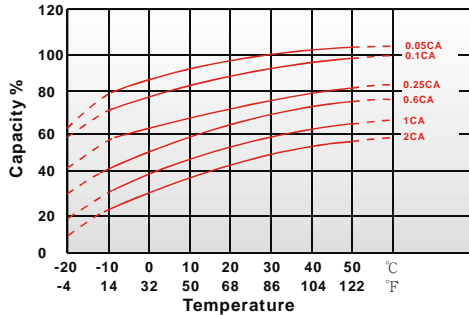

Capacity Retention Characteristic

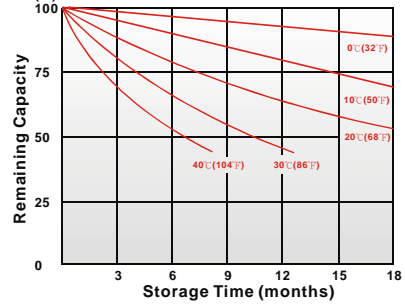

Cycle Service Life

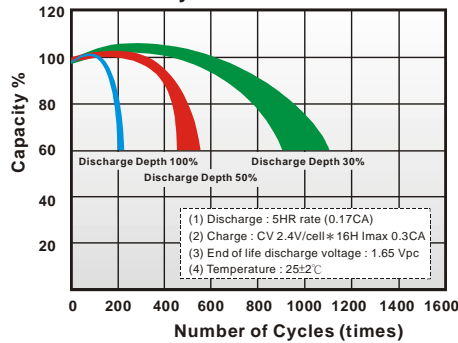

Trickle (or float) Service Life

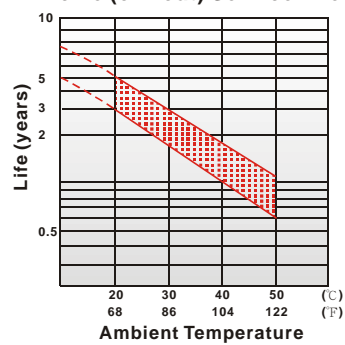

### - PERFORMANCE DATA

#### Discharge Rates in Watts to Various End Voltages at 25°C(77°F)

End Voltage		1.85V	1.80V	1.75V	1.70V	1.67V	1.65V	1.60V
Time								
5	min	147	161	173	185	191	196	208
10	min	108	114	119	125	128	131	135
15	min	78.7	84.0	88.2	92.2	94.2	96.0	99.5
30	min	42.3	45.3	47.2	48.7	49.5	50.3	51.3
60	min	30.2	31.7	32.4	32.8	33.2	33.5	33.8
120	min	19.2	19.8	20.2	20.7	20.8	21.0	21.2
180	min	12.8	13.2	13.4	13.6	13.6	13.7	13.8
240	min	10.3	10.5	10.7	10.8	10.9	10.9	11.0
300	min	8.75	8.90	8.98	9.07	9.10	9.15	9.37
600	min	5.42	5.52	5.58	5.66	5.68	5.72	5.75
1200	min	2.62	2.69	2.74	2.78	2.80	2.82	2.83

#### - Discharge Rates in Amperes to Various End Voltages at 25°C(77°F)

End Voltage		1.85V	1.80V	1.75V	1.70V	1.67V	1.65V	1.60V
Time								
5	min	78.9	92.9	103	109	111	113	115
10	min	55.6	62.1	64.2	68.2	70.4	72.3	75.7
15	min	40.8	46.4	49.8	52.6	54.3	54.9	56.2
30	min	21.4	23.8	25.2	26.5	27.2	27.8	28.8
60	min	15.3	16.1	16.5	16.9	17.1	17.3	17.5
120	min	9.34	9.72	9.87	10.0	10.1	10.2	10.3
180	min	6.45	6.63	6.72	6.83	6.87	6.92	6.99
240	min	5.48	5.61	5.69	5.76	5.79	5.84	5.91
300	min	4.77	4.86	4.93	5.00	5.02	5.05	5.08
600	min	2.55	2.61	2.65	2.69	2.71	2.74	2.77
1200	min	1.29	1.34	1.36	1.38	1.39	1.40	1.43

All data on the spec. sheet is an average value:

The tolerance range :  $X < 6\text{min}$ (+15%~-15%),  $6\text{min} \leq X < 10\text{min}$ (+12%~-12%),  $10\text{min} \leq X < 60\text{min}$ (+8%~-8%),  $X \geq 60\text{min}$ (+5%~-5%)

120219-1J



**KUNG LONG**

Issuing Date: 04-Jan-2023

Revision Date: 04-Jan-2023

Revision Number: 5

# SAFETY DATA SHEET

## 1. IDENTIFICATION OF THE SUBSTANCE/MIXTURE AND OF THE COMPANY/UNDERTAKING

### Product identifier

**Product Name:** Valve Regulated Lead-Acid Battery

### Other means of identification

**Synonyms:** None

### Recommended use of the chemical and restrictions on use

**Recommended Use:** Lead-Acid (Non-Spillable) Battery

**Uses advised against:** No information available

### Details of the supplier of the safety data sheet

**Supplier Name:** Kung Long Batteries Industrial Co., Ltd.

**Supplier Address:** No. 6, Tzu-Li 3 Rd. Nantou City 54067, Taiwan

### Manufactory Address:

**Taiwan:** No. 6, Tzu-Li 3 Rd. Nantou City 54067, Taiwan

**Vietnam: 1.)** 40-Ba Chanh Thau-Kp2-TT. Ben Luc-Huyen Ben Luc- Tinh Long An Vietnam

**2.)** Cum Cong Nghiep Duc My-xa Duc Hoa Dong-Huyen Duc Hoa- Tinh Long An 81999 Vietnam

**Supplier Phone Number:** Phone:+886-49-2254777

Fax:+886-49-2255139

Contact Phone:+886-49-2254777

**Supplier Email:** [sales@mail.klb.com.tw](mailto:sales@mail.klb.com.tw)

**Supplier Website:** <http://www.KLB.com.tw>

**Emergency telephone number:** +886-49-2254777

## 2. HAZARDS IDENTIFICATION

### Classification

This chemical is not considered hazardous by the 2012 OSHA Hazard Communication Standard (29 CFR 1910.1200)

This product is an article which is a sealed battery and as such does not require an MSDS per the OSHA hazard communication standard unless ruptured. The hazards indicated are for a ruptured battery.

Acute toxicity - Oral	Category 4
Acute toxicity - Inhalation (Gases)	Category 4
Acute toxicity - Inhalation (Vapors)	Category 4
Acute toxicity - Inhalation (Dusts/Mists)	Category 4
Skin corrosion/irritation	Category 1 Sub-category A
Serious eye damage/eye irritation	Category 2
Carcinogenicity	Category 1A
Reproductive toxicity	Category 1A
Specific target organ toxicity (repeated exposure)	Category 2

### GHS Label elements, including precautionary statements

#### Emergency Overview

**Signal word** Danger**Hazard Statements**

Harmful if swallowed

Harmful if inhaled

Causes severe skin burns and eye damage

Causes serious eye irritation

May cause cancer

May damage fertility or the unborn child

**May cause damage to organs through prolonged or repeated exposure**

This product is an article which contains a chemical substance. Safety information is given for exposure to the article as sold. Intended use of the product should not result in exposure to the chemical substance. This is a battery. In case of rupture: the above hazards exist.

**Appearance:** Gray black cuboid battery**Physical State:** Solid**Odor:** Odorless**Precautionary Statements - Prevention**

Obtain special instructions before use

Do not handle until all safety precautions have been read and understood

Use personal protective equipment as required

Wash face, hands and any exposed skin thoroughly after handling

Do not eat, drink or smoke when using this product

Use only outdoors or in a well-ventilated area

Do not breathe dust/fume/gas/mist/vapors/spray

**Precautionary Statements - Response**

Immediately call a POISON CENTER or doctor/physician

Specific treatment (see supplemental first aid instructions on this label)

**Eyes**

IF IN EYES: Rinse cautiously with water for several minutes. Remove contact lenses, if present and easy to do. Continue rinsing, Immediately call a POISON CENTER or doctor/physician

**Skin**

IF ON SKIN (or hair): Remove/Take off immediately all contaminated clothing. Rinse skin with water/shower.

Wash contaminated clothing before reuse

**Inhalation**

IF INHALED: Remove victim to fresh air and keep at rest in a position comfortable for breathing.

Call a POISON CENTER or doctor/physician if you feel unwell.

Immediately call a POISON CENTER or doctor/physician

**Ingestion**

IF SWALLOWED: Call a POISON CENTER or doctor/physician if you feel unwell

Rinse mouth

Do NOT induce vomiting

**Precautionary Statements - Storage**

Store locked up

**Precautionary Statements - Disposal**

Dispose of contents/container to an approved waste disposal plant

**Hazards not otherwise classified (HNOC)**

Not applicable

**Unknown Toxicity**

0.6% of the mixture consists of ingredient(s) of unknown toxicity

**Other information**

Very toxic to aquatic life with long lasting effects

**Interactions with Other Chemicals**

Use of alcoholic beverages may enhance toxic effects.

### 3. COMPOSITION/INFORMATION ON INGREDIENTS

Chemical characterization: Mixtures

※PBB spices or PBDE spices is not involved

Chemical	CAS No	Weight-%	Trade Secret
Lead	7439-92-1	45 ~ 60%	*
Lead dioxide	1309-60-0	15 ~ 25%	*
Sulfuric acid (Electrolyte)	7664-93-9	15 ~ 20%	*
Calcium (Lead calcium alloy)	7440-70-2	<0.06%	*
Tin	7440-31-5	<0.6%	*
Arsenic (Inorganic)	7440-38-2	<0.0006%	*
Non-Hazardous Materials	N/A	5 ~ 10%	*

**(The non-hazardous materials include ABS plastic, glass fiber, rubber, copper, expoxide-resin glue)**

\*The exact percentage (concentration) of composition has been withheld as a trade secret

### 4. FIRST AID MEASURES

#### First aid measures

##### General Advice

First aid is upon rupture of sealed battery.

##### Eye Contact

Rinse immediately with plenty of water, also under the eyelids, for at least 15 minutes. Keep eye wide open while rinsing. Do not rub affected area. Seek immediate medical attention/advice. Remove contact lenses, if present and easy to do. Continue rinsing.

##### Skin Contact

Immediate medical attention is required. Wash off immediately with soap and plenty of water while removing all contaminated clothes and shoes.

##### Inhalation

Remove to fresh air. If symptoms persist, call a physician. If breathing has stopped, give artificial respiration. Get medical attention immediately. If not breathing, give artificial respiration. Avoid direct contact with skin. Use barrier to give mouth-to-mouth resuscitation. If breathing is difficult, (trained personnel should) give oxygen. Seek immediate medical attention/advice. Delayed pulmonary edema may occur.

##### Ingestion

Do NOT induce vomiting. Rinse mouth. Rinse mouth immediately and drink plenty of water. Never give anything by mouth to an unconscious person. Call a physician or poison control center immediately.

##### Self-protection of the first aider

Ensure that medical personnel are aware of the material(s) involved, take precautions to protect themselves and prevent spread of contamination. Avoid contact with skin, eyes or clothing. Avoid direct contact with skin. Use barrier to give mouth-to-mouth resuscitation. Use personal protective equipment as required. Wear personal protective clothing (see section 8).

#### Most important symptoms and effects, both acute and delayed

##### Most Important Symptoms and Effects

Burning sensation. Lead poisoning is characterized by a metallic taste in the mouth, loss of appetite, indigestion, nausea, vomiting, constipation, sleep disturbances and overall weakness. Severe exposures can lead to shock, circulatory collapse and death.

#### Indication of any immediate medical attention and special treatment needed

##### Notes to Physician

Treat symptomatically. Product is a corrosive material. Use of gastric lavage or emesis is contraindicated. Possible perforation of stomach or esophagus should be investigated. Do not give chemical antidotes. Asphyxia from glottal edema may occur. Marked decrease in blood pressure may occur with moist rales, frothy sputum and high pulse pressure.

## 5. FIRE-FIGHTING MEASURES

### Suitable Extinguishing Media

Use extinguishing measures that are appropriate to local circumstances and the surrounding environment.

### Unsuitable extinguishing media

CAUTION: Use of water spray when fighting fire may be inefficient.

### Specific Hazards Arising from the Chemical

The product causes burns of eyes, skin and mucous membranes. Thermal decomposition can lead to release of irritating gases and vapors.

**Uniform Fire Code** Corrosive: Acid-Liquid  
Toxic: Liquid

### Hazardous Combustion Products

Carbon oxides

### Explosion Data

**Sensitivity to Mechanical Impact** No

**Sensitivity to Static Discharge** No

### Protective equipment and precautions for firefighters

As in any fire, wear self-contained breathing apparatus pressure-demand, MSHA/NIOSH (approved or equivalent) and full protective gear.

## 6. ACCIDENTAL RELEASE MEASURES

### Personal precautions, protective equipment and emergency procedures

**Personal Precautions** Attention! Corrosive material. Avoid contact with skin, eyes or clothing. Ensure adequate ventilation. Use personal protective equipment as required. Evacuate personnel to safe areas. Keep people away from and upwind of spill/leak. Avoid generation of dust.

**Other Information** Refer to protective measures listed in Sections 7 and 8.

### Environmental Precautions

**Environmental Precautions** Refer to protective measures listed in Sections 7 and 8. Prevent further leakage or spillage if safe to do so. Should not be released into the environment. Do not allow to enter into soil/subsoil. Prevent product from entering drains.

### Methods and material for containment and cleaning up

**Methods for Containment** Prevent further leakage or spillage if safe to do so.

**Methods for cleaning up** Pick up and transfer to properly labeled containers.

## 7. HANDLING AND STORAGE

### Precautions for safe handling

**Handling** In case of rupture: Handle in accordance with good industrial hygiene and safety practice. Avoid contact with skin, eyes or clothing. In case of insufficient ventilation, wear suitable respiratory equipment. Use only with adequate ventilation and in closed systems. Do not eat, drink or smoke when using this product. Take off contaminated clothing and wash before reuse.

### Conditions for safe storage, including any incompatibilities

**Storage** Keep containers tightly closed in a dry, cool and well-ventilated place. Protect from moisture. Store locked up. Keep out of the reach of children. Store away from other materials.

**Incompatible Products** Acids. Bases. Oxidizing agent.

## 8. EXPOSURE CONTROLS/PERSONAL PROTECTION

### Control parameters

#### Exposure Guidelines

Chemical Name	ACGIH TLV	OSHA PEL	NIOSH IDLH
Lead 7439-92-1	TWA: 0.05 mg/m <sup>3</sup>	TWA: 50 µg/m <sup>3</sup> TWA: 50 µg/m <sup>3</sup> Pb Action Level: 30 µg/m <sup>3</sup> Poison, See 29 CFR 1910.1025 Action Level: 30 µg/m <sup>3</sup> Pb Poison, See 29 CFR 1910.1025	IDLH: 100 mg/m <sup>3</sup> TWA: 0.050 mg/m <sup>3</sup>
Lead dioxide 1309-60-0	TWA: 0.05 mg/m <sup>3</sup> Pb	TWA: 50 µg/m <sup>3</sup> Pb Action Level: 30 µg/m <sup>3</sup> Pb Poison, See 29 CFR 1910.1025	IDLH: 100 mg/m <sup>3</sup> Pb TWA: 0.050 mg/m <sup>3</sup> Pb
Sulfuric acid 7664-93-9	TWA: 0.2 mg/m <sup>3</sup> thoracic fraction	TWA: 1 mg/m <sup>3</sup> (vacated) TWA: 1 mg/m <sup>3</sup>	IDLH: 15 mg/m <sup>3</sup> TWA: 1 mg/m <sup>3</sup>

ACGIH TLV: American Conference of Governmental Industrial Hygienists - Threshold Limit Value OSHA PEL: Occupational Safety and Health Administration - Permissible Exposure Limits NIOSH IDLH Immediately Dangerous to Life or Health

#### Other Exposure Guidelines

Vacated limits revoked by the Court of Appeals decision in AFL-CIO v. OSHA, 965 F.2d 962 (11th Cir., 1992) See section 15 for national exposure control parameters

#### Appropriate engineering controls

#### Engineering Measures

Showers  
Eyewash stations  
Ventilation systems

#### Individual protection measures, such as personal protective equipment

#### Eye/Face Protection

None required for consumer use. If splashes are likely to occur: Face protection shield.

#### Skin and Body Protection

Wear protective gloves and protective clothing. Long sleeved clothing. Chemical resistant apron. Impervious gloves.

#### Respiratory Protection

No protective equipment is needed under normal use conditions. If exposure limits are exceeded or irritation is experienced, ventilation and evacuation may be required.

#### Hygiene Measures

Handle in accordance with good industrial hygiene and safety practice. Do not eat, drink or smoke when using this product. Take off contaminated clothing and wash before reuse. Avoid contact with skin, eyes or clothing. Wear suitable gloves and eye/face protection. Contaminated work clothing should not be allowed out of the workplace. Regular cleaning of equipment, work area and clothing is recommended. Wash hands before breaks and immediately after handling the product. For environmental protection, remove and wash all contaminated protective equipment before re-use.

## 9. PHYSICAL AND CHEMICAL PROPERTIES

### Physical and Chemical Properties

<b>Physical State</b>	Solid	<b>Odor</b>	Odorless
<b>Appearance</b>	Cuboid battery	<b>Odor Threshold</b>	No information available
<b>Color</b>	Gray black		

<u>Property</u>	<u>Values</u>	<u>Remarks Method</u>
pH	No data available	None known
Melting / freezing point	327.4°C	Lead
Boiling point / boiling range		Lead
Flash Point	1740°C	None known
Evaporation Rate	No data available	None known
Flammability (solid, gas)	No data available	None known
Flammability Limit in Air	No data available	
Upper flammability limit		
Lower flammability limit	No data available	
Vapor pressure	No data available	Electrolyte
Vapor density	<0.3mmHg @25°C	Electrolyte
Specific Gravity	3.4	Electrolyte
Water Solubility	1.170-1.40	Electrolyte
Solubility in other solvents	100%	None known
Partition coefficient: n-octanol/water	No data available	None known
Autoignition temperature	No data available	None known
Decomposition temperature	No data available	None known
Kinematic viscosity	No data available	None known
Dynamic viscosity	No data available	None known
Explosive properties	No data available	
Oxidizing Properties	No data available	

### Other Information

<b>Softening Point</b>	
<b>VOC Content (%)</b>	No data available
<b>Particle Size</b>	No data available
<b>Particle Size Distribution</b>	No data available

## 10. STABILITY AND REACTIVITY

### Reactivity

No data available.

### Chemical Stability

Stable under recommended storage conditions.

### Possibility of Hazardous Reactions

None under normal processing.

### Hazardous Polymerization

Hazardous polymerization does not occur.

### Conditions to Avoid

Exposure to air or moisture over prolonged periods.

Avoid shorting circuit or sparks near battery. Avoid prolonged over-charging.

Use only approved charging methods. Do not charge in gas tight containers. Keep battery away from strong oxidizers, sparks, open flames.

### Incompatible Materials

Acids. Bases. Oxidizing agent.

### Hazardous Decomposition Products

Carbon oxides.

## 11. TOXICOLOGICAL INFORMATION

### Information on likely routes of exposure



<b>Product Information</b>	Product does not present an acute toxicity hazard based on known or supplied information. In case of rupture:
<b>Inhalation</b>	Specific test data for the substance or mixture is not available. Corrosive by inhalation. (based on components). Inhalation of corrosive fumes/gases may cause coughing, choking, headache, dizziness and weakness for several hours. Pulmonary edema may occur with tightness in the chest, shortness of breath, bluish skin, decreased blood pressure and increased heart rate. Inhaled corrosive substances can lead to a toxic edema of the lungs. Pulmonary edema can be fatal. May cause irritation of respiratory tract.
<b>Eye Contact</b>	Specific test data for the substance or mixture is not available. Causes burns (based on components). Corrosive to the eyes and may cause severe damage including blindness. Expected to be an irritant based on components.
<b>Skin Contact</b>	Specific test data for the substance or mixture is not available. Corrosive (based on components). Causes burns.
<b>Ingestion</b>	Specific test data for the substance or mixture is not available. Causes burns (based on components). Ingestion causes burns of the upper digestive and respiratory tracts. May cause severe burning pain in the mouth and stomach with vomiting and diarrhea of dark blood. Blood pressure may decrease. Brownish or yellowish stains may be seen around the mouth. Swelling of the throat may cause shortness of breath and choking. May cause lung damage if swallowed. May be fatal if swallowed and enters airways. Ingestion may cause irritation to mucous membranes. Ingestion may cause gastrointestinal irritation, nausea, vomiting and diarrhea. May be harmful if swallowed.

**Component Information**

Chemical Name	Oral LD50	Dermal LD50	Inhalation LC50
Sulfuric acid 7664-93-9	= 2140 mg/kg ( Rat )	-	= 510 mg/m3 ( Rat ) 2 h

**Information on toxicological effects**

**Symptoms** Erythema (skin redness). Burning. May cause blindness. Coughing and/or wheezing. May cause redness and tearing of the eyes.

**Delayed and immediate effects as well as chronic effects from short and long-term exposure**

**Sensitization** No information available.

**Mutagenic Effects** No information available.

**Carcinogenicity** The table below indicates whether each agency has listed any ingredient as a carcinogen.

Chemical Name	ACGIH	IARC	NTP	OSHA
Lead 7439-92-1	A3	Group 2A	Reasonably Anticipated	X
Lead dioxide 1309-60-0	A3	Group 2A	Reasonably Anticipated	X
Sulfuric acid 7664-93-9	A3	Group 1	Known	X

**ACGIH (American Conference of Governmental Industrial Hygienists)**

A2 - Suspected Human Carcinogen

A3 - Animal Carcinogen

**IARC (International Agency for Research on Cancer)**

Group 1 - Carcinogenic to Humans

Group 2A - Probably Carcinogenic to Humans

**NTP (National Toxicology Program)**

Known - Known Carcinogen

Reasonably Anticipated - Reasonably Anticipated to be a Human Carcinogen

**OSHA (Occupational Safety and Health Administration of the US Department of Labor)**

X - Present

<b>Reproductive Toxicity</b>	Product is or contains a chemical which is a known or suspected reproductive hazard. Contains a known or suspected reproductive toxin.
<b>Developmental Toxicity</b>	Contains ingredients that have suspected developmental hazards.
<b>STOT - single exposure</b>	No information available.
<b>STOT - repeated exposure</b>	Causes damage to organs through prolonged or repeated exposure. Based on classification criteria from the 2012 OSHA Hazard Communication Standard (29 CFR 1910.1200), this product has been determined to cause systemic target organ toxicity from chronic or repeated exposure. (STOT RE).
<b>Chronic Toxicity</b>	Chronic exposure to corrosive fumes/gases may cause erosion of the teeth followed by jaw necrosis. Bronchial irritation with chronic cough and frequent attacks of pneumonia are common. Gastrointestinal disturbances may also be seen. Contains a known or suspected carcinogen. Contains a known or suspected reproductive toxin. Possible risk of irreversible effects. Avoid repeated exposure. Prolonged exposure may cause chronic effects. May cause adverse effects on the bone marrow and blood-forming system. Lead compounds may be absorbed by ingestion, by inhalation and through the skin. Lead may damage kidney function, the blood forming system and the reproductive system.
<b>Target Organ Effects</b>	Respiratory system. Eyes. Skin. Gastrointestinal tract (GI). Reproductive System. Blood. Central Nervous System (CNS). Gingival Tissue. Kidney. Teeth. Cardiovascular system. Hematopoietic system. Immune system. May damage the unborn child.
<b>Aspiration Hazard</b>	No information available.

#### Numerical measures of toxicity Product Information

The following values are calculated based on chapter 3.1 of the GHS document

#### **ATEmix (oral)**

500.00 mg/kg

#### **ATEmix (inhalation-gas)**

5,625.00 ppm (4 hr)

#### **ATEmix (inhalation-dust/mist)**

1.10 mg/l

#### **ATEmix (inhalation-vapor)**

14.00 ATEmix

## 12. ECOLOGICAL INFORMATION

This product contains a chemical which is listed as a severe marine pollutant according to DOT

#### Ecotoxicity

Very toxic to aquatic life with long lasting effects.

Chemical Name	Toxicity to Algae	Toxicity to Fish	Toxicity to Microorganisms	Daphnia Magna (Water Flea)
Lead 7439-92-1		96h LC50: = 0.44 mg/L (Cyprinus carpio) 96h LC50:= 1.17 mg/L (Oncorhynchus mykiss) 96h LC50: = 1.32 mg/L (Oncorhynchus mykiss)		48h EC50: = 600 µg/L
Sulfuric acid 7664-93-9		96h LC50: > 500 mg/L (Brachydanio rerio)		24h EC50: = 29 mg/L

**Persistence and Degradability**

No information available.

**Bioaccumulation**

No information available.

**Other adverse effects**

No information available.

**13. DISPOSAL CONSIDERATIONS**

**Waste treatment methods**

**Disposal Methods**

This material, as supplied, is a hazardous waste according to federal regulations (40 CFR 261).

**Contaminated Packaging**

Dispose of contents/containers in accordance with local regulations.

**US EPA Waste Number**

D002 D004 D008

Chemical Name	RCRA	RCRA - Basis for Listing	RCRA - D Series Wastes	RCRA - U Series Wastes
Lead 7439-92-1	(hazardous constituent – no waste number)	Included in waste streams: F035, F037, F038, F039, K002, K003, K005, K046, K048, K049, K051, K052, K061, K062, K064, K065, K066, K069, K086, K100, K176	= 5.0 mg/L regulatory level	

**California Hazardous Waste Codes 792**

This product contains one or more substances that are listed with the State of California as a hazardous waste.

Chemical Name	California Hazardous Waste
Lead 7439-92-1	Toxic
Lead dioxide 1309-60-0	Toxic
Sulfuric acid 7664-93-9	Toxic Corrosive

**14. TRANSPORT INFORMATION**

**Transportation Information**

Since **LONG** batteries meet the requirement of “Non-Spillable” and Exempt from Hazardous Goods regulations, they can be transported by Air, Sea, or Land transportation. All batteries are labeled as “Non-Spillable” individually. Therefore, **LONG** batteries are not suitable for NA or UN number.

**U.S. DOT :**

DOT-Our Non-spillable batteries are **Not subject to DG regulations**, since they meet the requirements of 49 CFR 173.159(d). They do not have an assigned UN number nor do they require additional DOT hazard labeling.

**EU- ADR/RID:** New and spent batteries are exempt from all ADR/RID (Special Provision 598)

**IATA / ICAO :**

IATA/ICAO- **LONG** batteries are exempt from **DG regulations**, and classified as a “Non-Spillable battery”. Our Non-spillable batteries are **Not subject to DG regulations**, since they meet the requirements of Packing Instructions **872** of Special Provision A67.

The **LONG** batteries are securely packaged, protected from short circuits and labeled “Non-Spillable”. They are good for transportation on either passenger aircraft or cargo aircraft.

**For all modes of transportation, each battery and outer package must be labeled :**

“Non-Spillable” or “Non-Spillable Battery”. This label must be visible during transportation.

**IMDG:**

**LONG** batteries are Non-spillable batteries. They meet the requirements of Special Provision 238 and are not subject to the provisions of the IMDG code.

## 15. REGULATORY INFORMATION

TSCA  
DSL

Complies  
All components are listed either on the DSL or NDSL.

**TSCA** - United States Toxic Substances Control Act Section 8(b) Inventory  
**DSL/NDSL** - Canadian Domestic Substances List/Non-Domestic Substances List

**US Federal Regulations****SARA 313**

Section 313 of Title III of the Superfund Amendments and Reauthorization Act of 1986 (SARA). This product contains a chemical or chemicals which are subject to the reporting requirements of the Act and Title 40 of the Code of Federal Regulations, Part 372

Chemical name	CAS No	Weight-%	SARA 313 - Threshold Values %
Lead - 7439-92-1	7439-92-1	45 - 60	0.1
Lead dioxide - 1309-60-0	1309-60-0	15 - 25	0.1
Sulfuric acid - 7664-93-9	7664-93-9	15 - 20	1.0

**SARA 311/312 Hazard Categories**

<b>Acute Health Hazard</b>	No
<b>Chronic Health Hazard</b>	No
<b>Fire Hazard</b>	No
<b>Sudden release of pressure hazard</b>	No
<b>Reactive Hazard</b>	No

**CWA (Clean Water Act)**

This product contains the following substances which are regulated pollutants pursuant to the Clean Water Act (40 CFR 122.21 and 40 CFR 122.42)

Chemical Name	CWA - Reportable Quantities	CWA - Toxic Pollutants	CWA - Priority Pollutants	CWA - Hazardous Substances
Lead - 7439-92-1		x	x	
Lead dioxide - 1309-60-0		x		
Sulfuric acid - 7664-93-9	1000 lb			x

**CERCLA**

This material, as supplied, contains one or more substances regulated as a hazardous substance under the Comprehensive Environmental Response Compensation and Liability Act (CERCLA) (40 CFR 302)

Chemical name	Hazardous Substances RQs	Extremely Hazardous Substances RQs	RQ
Lead 7439-92-1	10 lb		RQ 10 lb final RQ RQ 4.54 kg final RQ
Sulfuric acid 7664-93-9	1000 lb	1000 lb	RQ 1000 lb final RQ RQ 454 kg final RQ

**US State Regulations****California Proposition 65**

This product contains the following Proposition 65 chemicals.

Chemical name	California Proposition 65
Lead - 7439-92-1	Carcinogen Developmental Female Reproductive
Lead dioxide - 1309-60-0	Carcinogen Developmental Female Reproductive Male Reproductive
Sulfuric acid - 7664-93-9	Carcinogen
Arsenic - 7440-38-2	Carcinogen

**U.S. State Right-to-Know Regulations**

Chemical name	New Jersey	Massachusetts	Pennsylvania	Rhode Island	Illinois
Lead 7439-92-1	X	X	X	X	X
Lead dioxide 1309-60-0	X	X	X	X	X
Sulfuric acid 7664-93-9	X	X	X	X	X
Tin 7440-31-5	X	X	X		
Calcium 7440-70-2	X	X	X		

**International Regulations**

**Mexico**

**National occupational exposure limits**

Chemical name	Carcinogen Status	Exposure Limits
Lead 7439-92-1 ( 45 - 60 )	A3	Mexico: TWA= 0.15 mg/m3
Lead dioxide 1309-60-0 ( 15 - 25 )	A3	Mexico: TWA 0.15 mg/m3
Sulfuric acid 7664-93-9 ( 15 - 20 )	A2	Mexico: TWA 1 mg/m3

Mexico - Occupational Exposure Limits - Carcinogens

A2 - Suspected Human Carcinogen

A3 - Confirmed Animal Carcinogen

**Canada**

**WHMIS Hazard Class**

Non-controlled

**EU Regulation:**

In accordance with EU2006/66/EC Battery Directive, VRLA batteries should present crossed-out wheeled bin symbol of lead together with the ISO recycling symbol. Does not contain any mercury, Hg, (<0.0005%) or cadmium, Cd, (<0.002%).

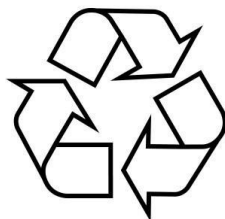

**16. OTHER INFORMATION**

NFPA	Health Hazards 3	Flammability 0	Instability 0	Physical and Chemical Hazards -
HMIS	Health Hazards 0	Flammability 0	Physical Hazard 0	Personal Protection X

Prepared By	Kung Long Batteries Industrial Co., Ltd.
Issuing Date	04-Jan-2023
Revision Date	04-Jan-2023
Revision Note	No information available5

**Disclaimer**

The information provided in this Safety Data Sheet is correct to the best of our knowledge, information and belief at the date of its publication. The information given is designed only as a guide for safe handling, use, processing, storage, transportation, disposal and release; and is not to be considered a warranty or quality specification. The information relates only to the specific material designated and may not be valid for such material used in combination with any other materials or in any process, unless specified in the text.

**End of Safety Data Sheet**